

# Datasheet



- Easy and powerful measurement system in combination with pulse counters or display
- To linear and angular movements as Tool automatic, wooden, marble glass processing machines, cylinder, hydraulic or pneumatic tire, effective stroke, trapdoors, etc.
- Version
  - EF: optical incremental encoder
- Easy mounting
- Impact resistant and self-extinguishing housing
- Resistance to solvents, gasoline, oil and grease



## Mechanical Data

Version	EF1000	EF2000	EF3000
Measuring Length [mm]	0 - 1200	0 - 2200	0 - 3200
Number of Cycles	500.000	400.000	300.000
Repeatability with Quadrupled Count	±0,15 mm	±0,02 mm	±0,3 mm
Resolution EF	600 impulse pro 240 mm		2.400 flank-vault
Color	gray RAL 7004		
Wight	400 g		
Speed	<0,7 m/s		
Operating Temperature	-10 to 70°C		
Relative Humidity	10 to 90 %		
IP-Rating	IP54		

## Electrical Data

Power Supply	10-30 VDC <60 mA / Push Pull 10-30 VDC (5VDC) / Line Driver
Output Current	<20 mA
Output Signal Line Driver	<b>Push-Pull</b> <b>TTL-LD1</b> 10-30Vdc out 5Vdc <b>TTL-LD2</b> 5Vdc out 5Vdc <b>TTL-LD3</b> 10-30Vdc out 10-30Vdc; 0 output every 240 mm wire pull
EFM	
Electrical Connection Cable Length [m]	2,5,10
Electromagnetic compatibility	2004/108/CE







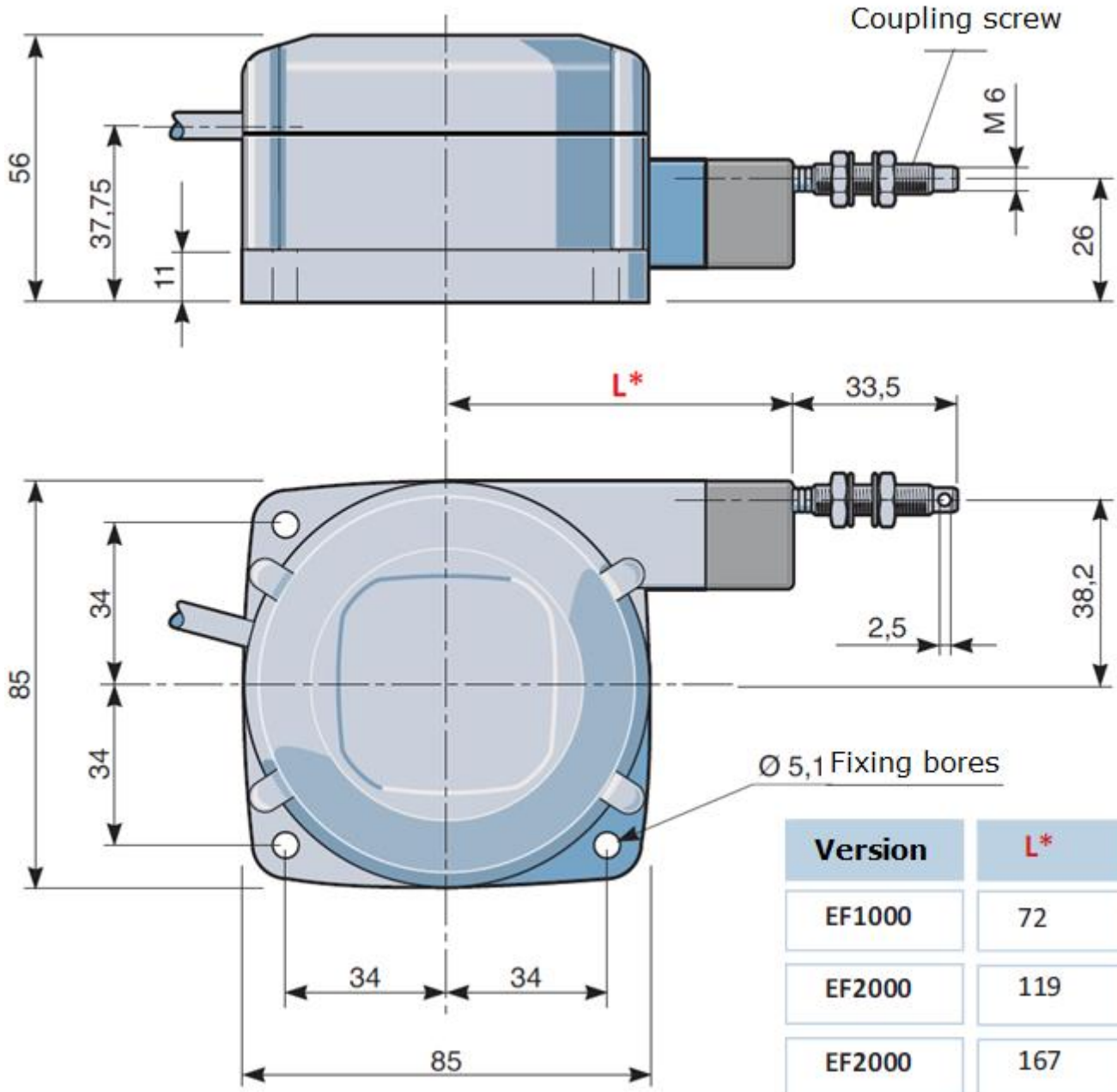

# Datasheet

## Dimension



# Datasheet

## Pin Assignment

Push-Pull		Line-Driver	
brown	10-30 VDC	brown	10-30 VDC
yellow	 <b>A</b>	yellow orange	 <b>A</b>
white	 <b>B</b>	white violet	 <b>B</b>
gray (zero)	 <b>Z</b>	gray black (zero)	 <b>Z</b>
green shield	GND not linked	green shield	GND not linked

## Ordering Example

<b>Type</b>	<b>EF</b>	-	<b>1000</b>	-	<b>PP</b>	-	<b>2m</b>
<b>EF</b>							
<b>Measuring Length</b>							
<b>1000</b>							
2000							
3000							
<b>Output Signal</b>							
<b>PP</b>	= PP						
TTL-LD1	= 10-30Vdc	out 5Vdc					
TTL-LD2	= 5Vdc	out 5Vdc					
TTL-LD3	= 10-30Vdc	out 10-30Vdc;					
<b>Cable Length</b>							
<b>2m</b>							
5m							
10m							